



## Pattern Blazer™

### High Power LED Pattern Projector for Machine Vision



*Figure 1. Pattern Blazer*

The Pattern Blazer™ is a high-power LED Fixed-Pattern Projector for structured lighting and stereovision in 3D machine vision. Pattern Blazer™ applications include determination of object shape and orientation, contour mapping of parts, surface defect detection, depth measurements, guidelines, edge detection, and alignment. A near infrared version is suited for video identification in long-range CCTV security and surveillance.

The Pattern Blazer projects patterns with an intensity that is at least 5 to 10X greater at the same distance than other “high power” LED Pattern projectors for similar pattern size and wavelength. It can be operated in either continuous, PWM or pulsed current modes. Extremely intense patterns at long working distances enables the use of 3D imaging in vast, well-lit areas including outdoor locations.

#### Typical Applications

- Vision guided robotics; object ID, pick & place
- 3D metrology; precision shape and volume measurement
- Road pavement inspection; structure and roughness
- Biometrics; gesture and facial recognition
- Logistics; box filling, palletizing

*Table 1. Base Models LED Options*

Option	LED Type	Wavelength	Array
<b>LED1</b>	Blue	Peak 470 nm (typ.)	Common cathode
<b>LED2</b>	Red	Peak 660 nm (typ.)	Common anode
<b>LED3</b>	White	400-700 nm; 4800K	Common cathode
<b>LED4</b>	NIR	Peak 860 nm (typ.)	Common anode

*Other wavelengths available on request.*



Patterns

The Pattern Blazer employs precision reticles patterned by photolithography which produce thinner lines, sharper edges, and more homogeneous illumination. There are seven standard optical patterns available supplied in interchangeable mounting frames. The patterns are sized to fill the field of 1” format C-mount camera lenses. **The linewidth of patterns with lines is 70 μm.**

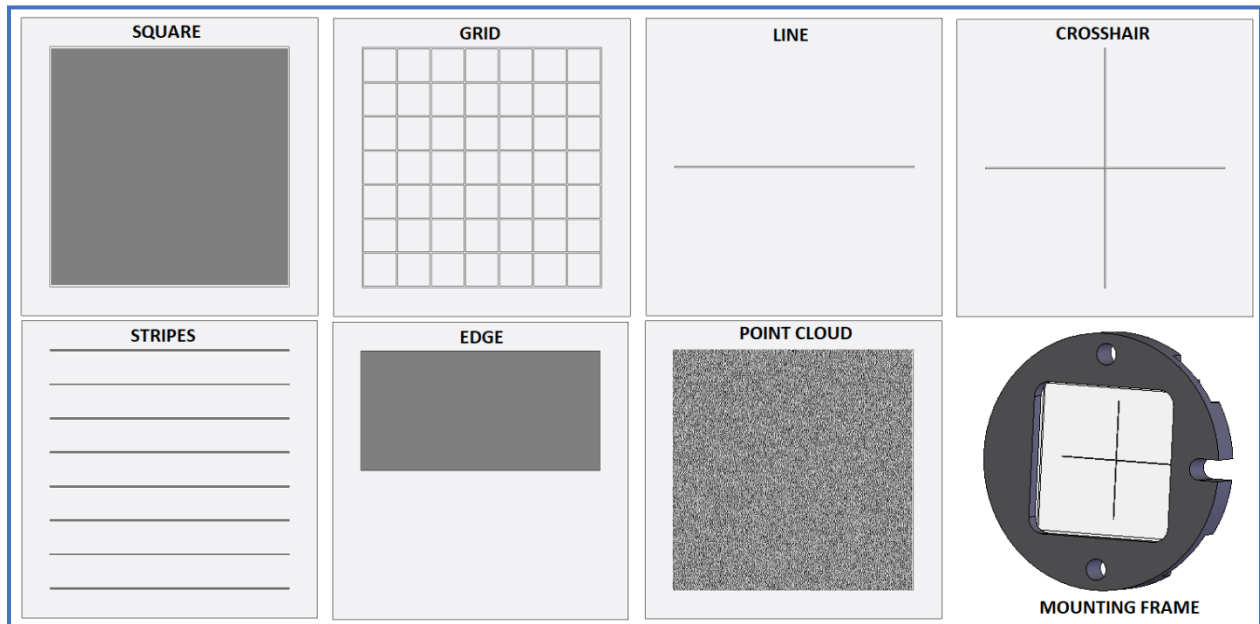

Figure 2. Available Patterns

*\*NOTES: Reverse negative images; dark grey areas are the projected light patterns. Custom patterns can be fabricated upon request. Alternate “Edge” pattern rotation must be requested at time of order.*

Table 2. Pattern Options

Option	Pattern
PAT1	Square
PAT2	Grid
PAT3	Line - Horizontal
PAT4	Line - Vertical
PAT5	Crosshair
PAT6	Stripes - Horizontal
PAT7	Stripes - Vertical
PAT8	Edge
PAT9	Point Cloud

**Available Accessory**  
**PIK1 - Pattern Installation Tool Kit**



## Lenses

The Pattern Blazer’s field of view is designed for 1” format C-mount lenses. Smaller field of view lenses can be used but will suffer from a higher drop in the intensity with field angle. High speed (low F/#/high NA) lenses produce the brightest pattern images.

**Table 3. C-Mount Lens Selections**

Option No.:	LENS1	LENS2	LENS3	LENS4	LENS5	LENS6	LENS7
Focal Length:	6.5	12.5	17	25	35	50	75
F/#:	1.4	1.4	0.95	0.85	1.4	0.85	1.8
FOV*:	82°	49°	37°	25°	18°	13°	9°
Min. Object Distance:	150 mm	100 mm	500 mm	170 mm	200 mm	240 mm	900 mm
Distortion at ≈1m WD:	8.0%	-2.1%	9.7%	1.2%	-0.15%	-0.60%	-0.06%
Spectral Range:	400-950 nm	400-1000 nm	400-1000 nm	400-1000 nm	400-1000 nm	400-1000 nm	400-1000 nm
Dimensions:	φ46 × L44 mm	φ51 × L68.5 mm	φ42 × L80.7 mm	φ65 × L85.5 mm	φ51 × L48.5 mm	φ65 × L81.5 mm	φ51 × L76.0 mm

\*FOV is based on the 11.3 mm width and length of the pattern reticles.

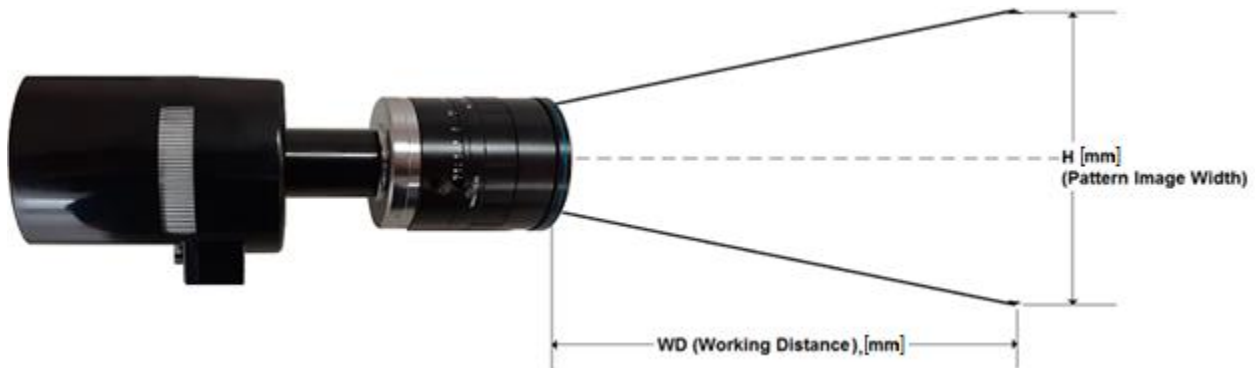

## Optical Performance with Grid Pattern

**Table 4.**

**Pattern Image Width H (Pattern Linewidth) [mm]**

		WD (Working Distance), [mm]									
		200	300	500	750	1000	2000	4000	6000	8000	10,000
Lens Focal Length [mm]	6.5	409 [2.5]	613 [3.8]	1021 [6.3]	1532 [9.5]	2043 [12.7]					
	12.5	201 [1.2]	290 [1.8]	468 [2.9]	691 [4.3]	914 [5.7]	1806 [11.22]	3589 [22.2]			
	17			390 [2.4]	582 [3.6]	774 [4.8]	1544 [9.6]	3084 [19.1]			
	25	96 [0.6]	142 [0.9]	232 [1.4]	345 [2.1]	458 [2.8]	911 [5.6]	1815 [11.2]	2720 [16.8]	3624 [22.5]	
	35		123 [0.8]	186 [1.2]	265 [1.6]	343 [2.1]	658 [4.1]	1286 [8.0]	1915 [11.9]	2543 [15.8]	3171 [19.6]
	50		74 [0.5]	120 [0.7]	177 [1.1]	234 [1.4]	462 [2.9]	918 [5.7]	1375 [8.5]	1831 [11.3]	2287 [14.2]
	75					158 [1.0]	317 [2.0]	636 [3.9]	955 [5.9]	1273 [7.9]	1592 [9.9]



**Table 5.**  
**Pattern Irradiance [mW/cm<sup>2</sup>]**  
**Blue LED, On-axis**  
**20A Drive Current**

		WD (Working Distance), [mm]									
		200	300	500	750	1000	2000	4000	6000	8000	10000
Lens Focal Length [mm]	6.5	8.5	3.9	1.4	0.6	0.4					
	12.5	81	35	12	5.2	2.9	0.7	0.2			
	17			23	10.4	5.9	1.5	0.4			
	25	279	130	49	23	13	3.6	1.0	0.4	0.3	
	35		266	98	45	25	6.6	1.7	0.8	0.4	0.3
	50		480	181	83	48	13	3.4	1.6	0.9	0.6
	75					82	17	3.6	1.4	0.7	0.5

**Table 6.**  
**Pattern Irradiance [mW/cm<sup>2</sup>]**  
**Red LED, On-axis**  
**20A Drive Current**

		WD (Working Distance), [mm]									
		200	300	500	750	1000	2000	4000	6000	8000	10000
Lens Focal Length [mm]	6.5	4.9	2.1	0.7	0.3	0.2					
	12.5	17	7.6	2.8	1.2	0.7	0.2	0.0			
	17			5.8	2.6	1.5	0.4	0.1			
	25	72	33	13	5.9	3.4	0.9	0.2	0.1	0.1	
	35		63	23	11	6.0	1.6	0.4	0.2	0.1	0.1
	50		133	50	23	13	3.5	0.9	0.4	0.3	0.2
	75					21	4.5	0.9	0.4	0.2	0.1

**Table 7.**  
**Pattern Illuminance [klx]**  
**White LED, On-axis**  
**20A Drive Current**

		WD (Working Distance), [mm]									
		200	300	500	750	1000	2000	4000	6000	8000	10000
Lens Focal Length [mm]	6.5	24	11	4	2	1					
	12.5	190	85	31	14	8	2	1			
	17			62	28	16	4	1			
	25	802	372	141	66	38	10	3	1	1	
	35		703	260	118	67	17	5	2	1	1
	50		1601	573	254	142	35	9	4	2	1
	75					236	49	10	4	2	1



**Table 8.**  
**Pattern Irradiance [mW/cm<sup>2</sup>]**  
**NIR LED, On-axis**  
**20A Drive Current**

		WD (Working Distance), [mm]									
		200	300	500	750	1000	2000	4000	6000	8000	10000
Lens Focal Length [mm]	6.5	4.9	2.1	0.7	0.3	0.2					
	12.5	17	7.6	2.8	1.2	0.7	0.2	0.0			
	17			5.8	2.6	1.5	0.4	0.1			
	25	72	33	13	5.9	3.4	0.9	0.2	0.1	0.1	
	35		63	23	11	6.0	1.6	0.4	0.2	0.1	0.1
	50		133	50	23	13	3.5	0.9	0.4	0.3	0.2
	75					21	4.5	0.9	0.4	0.2	0.1

**LED Characteristics**

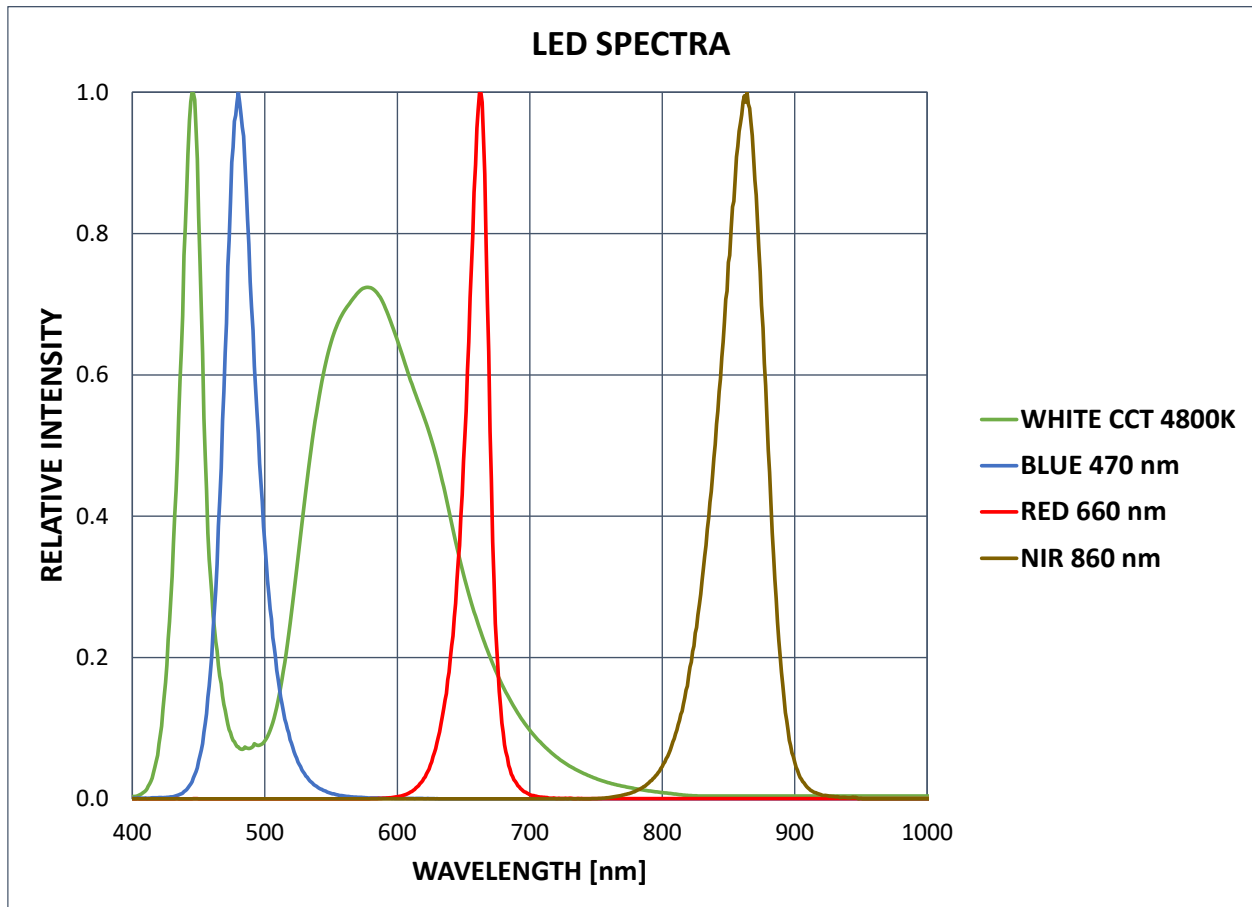

*Figure 3. LED Spectra*

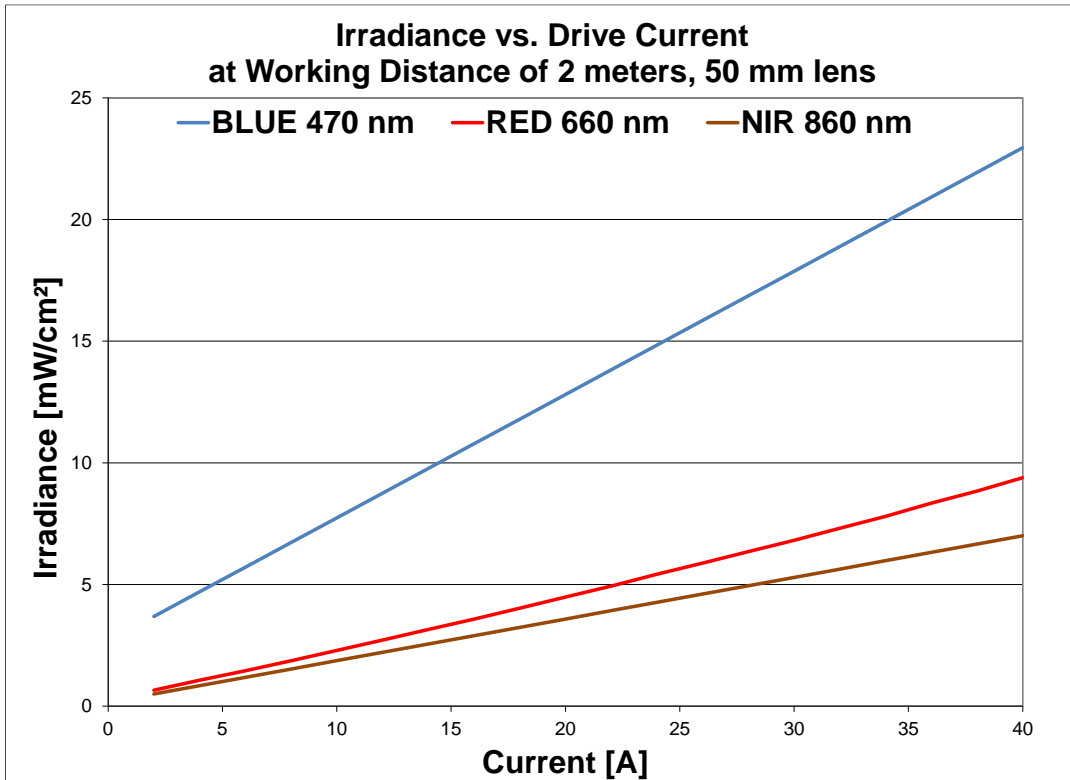

Figure 4. Irradiance vs. Drive Current

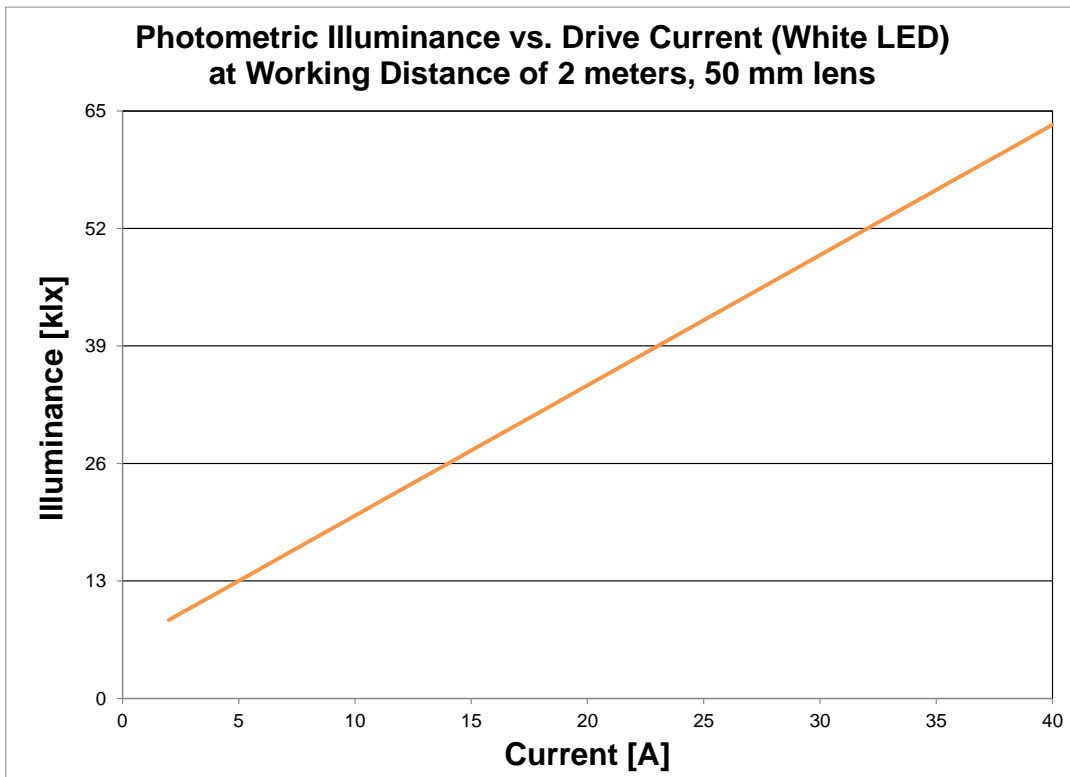

Figure 5. Illuminance vs. Drive Current (White LED)



LED Driver/Controller



Table 9. Driver/Controller Options

Option	Array	LED Type
DRV1	Common cathode	Blue White
DRV2	Common anode	Red NIR

Available Accessory DIN1 - DIN Rail Mount

Figure 6. Front Panel Controls



USB	Bootloader access for firmware updates (USB Type B)
CONTROL	RS-485 communication (DB-15HD, Female)
PWR IN	+24 VDC, 200-250 W (D-SUB Combo Socket/Pin 12-14 AWG )
MODULE	40 ADC (Max CW), 50 ADC (Max Pulsed) output to LED Module (D-SUB 7W2)

Figure 7. and Table 10. CONTROL PINOUT

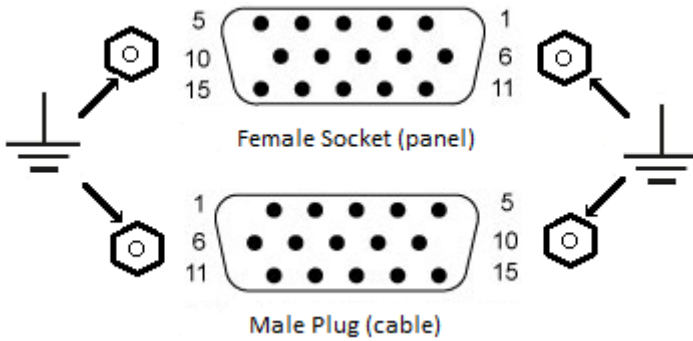

PIN	FUNCTION	DIR
1	RS485+ (A)	I/O
2	TRIG+	I
3	GPIO +3.3V	O
4	GPIO AIN (POT)	I
5	RS485+ (A)	I/O
6	GND	
7	GND	
8	TRIG-	I
9	GND	
10	RS485 COM	
11	RS485-(B) I/O	I/O
12	GPIO +3.3V	O
13	GND	
14	/BOOT EN	I
15	RS485- (B)	I/O



**Table 11. Pattern Blazer Operating Specifications**

PARAMETER	SPECIFICATION	COMMENT
<b>LED wavelengths*</b>	Blue	Peak wavelength 470 nm (typ.)
	White	CCT 4800K (typ.)
	Red	Peak wavelength 660 nm (typ.)
	NIR	Peak wavelength 860 nm (typ.)
<b>Drive current</b>	Continuous 40A max.	Wavelength dependent
	Pulsed 50A max.	30% duty cycle maximum
<b>Forward voltage</b>	Limit: 5.0 V	Requires constant current operation
<b>Total Drive Power</b>	250 Watts max.	At max. drive current
<b>Electrical connector</b>	D-SUB 7W2	Power and comms, internal shielding
<b>Cooling</b>	Forced air	PWM smart control
<b>Operating temperature</b>	-40 °C to 40 °C	Depending on drive conditions
<b>Size and Weight</b>	155 (W) x 92.5 (D) x 95 (H) mm, 0.8 kg	Without lens attached
<b>Lifetime (hours)</b>	-	Depends on drive conditions and temperature

*\*Peak wavelength and CCT vary with drive current.*

**Table 12. Driver/Controller Operating Specifications**

PARAMETER	SPECIFICATION	COMMENT
<b>Type</b>	1 Channel constant current, dimmable	Continuous or pulsed by external trigger
<b>Output Voltage</b>	Determined by the LED module	Drive current compliance voltage
<b>Output Current</b>	2 to 40 ADC	Continuous
	50 ADC Max	Pulsed
<b>Input Voltage</b>	+24 VDC +/- 5%	200W typical for 40A output
<b>Efficiency</b>	77% typical	at 40A output
<b>Current Ripple</b>	2% (P-P)	at 25ADC output current and 95W output power
<b>Dimming</b>	Analog	Potentiometer
	Digital	via MODBUS
<b>External Trigger</b>	3.3V TTL	user enabled
	50 µsec min pulse width 250 Hz - 2 kHz switching frequency	with 1m long driver cable
<b>LED Module I/O</b>	Thermistor in LED module	monitoring
	Fan power (24 VDC) and PWM	cooling, intelligent control
<b>Connectivity</b>	RS-485 (Modbus Protocol)	
<b>Size and Weight</b>	168.3 (W) X 142 (D) X 46.5 (H) mm, 1.0 kg	





Installation Control Drawings

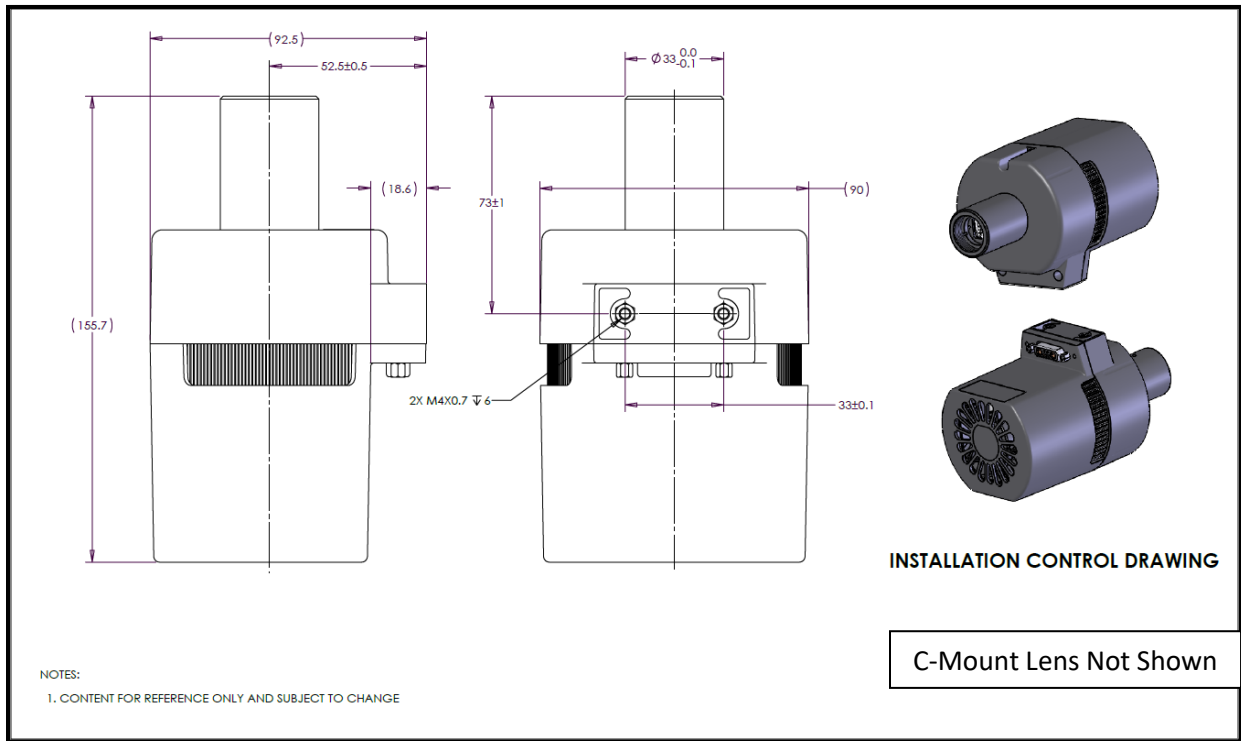

Figure 8. Pattern Blazer ICD

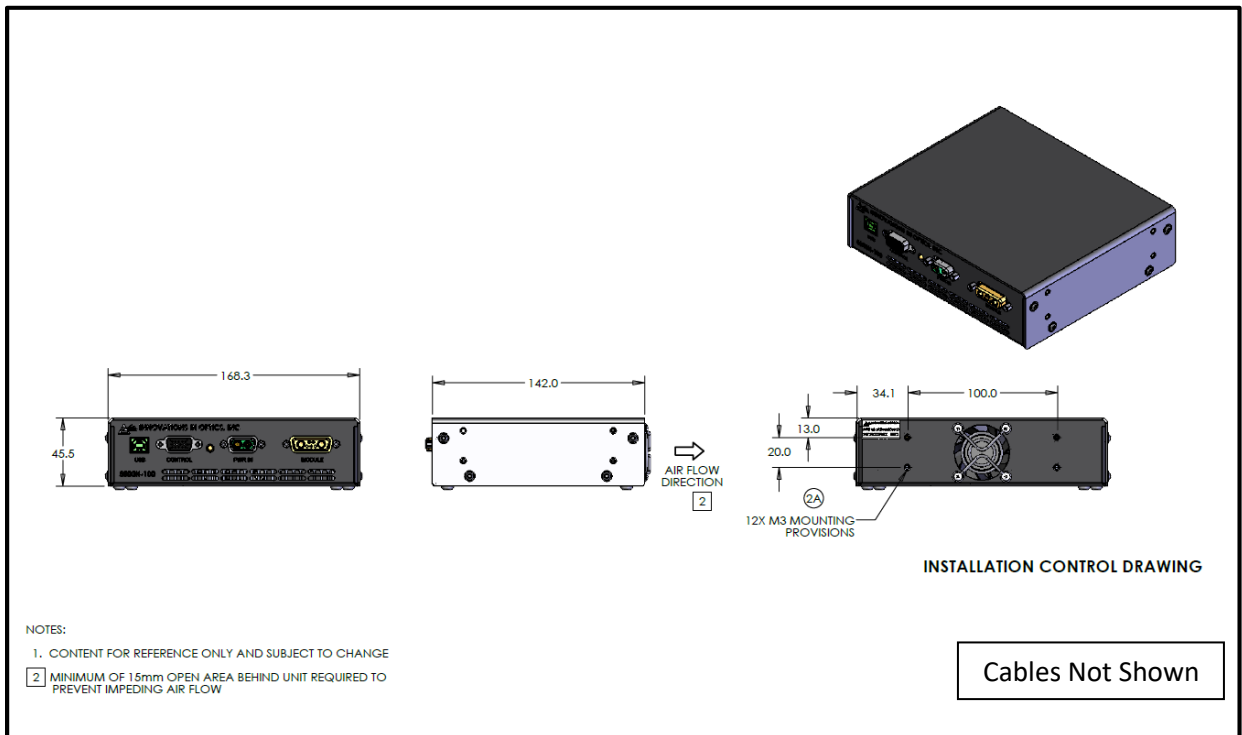

Figure 9. Driver/Controller ICD



Cables and Accessories

Table 13. MODULE Cables: Pattern Blazer to Driver (Required)

Option	Description
MODC1	MODULE Cable 2 meters
MODC2	MODULE Cable 4 meters



Table 14. Communication Cables (Optional, not shown)

Option	Description
COMC1	RS-485 to USB-A Converter Cable 1.8 meters
COMC2	RS-485 to USB-A Converter Box with Switch and Dimmer (a development tool)

Table 15. Power Cables to Connect Driver to 24VDC Supply (Optional, supply not included)

Option	Description
POWC3	24VDC Power Cable 1 meter
POWC4	24VDC Power Cable 2 meters



Table 16. External Power Adapters – Universal AC to 24 VDC, DOE VI Efficiency (Optional)

Option	Description
EXPA1	300W, Fan-less, IP41, Medical and ITE approvals
EXPA2	200W, Built-in PWM Fan



The products, their specifications and other information appearing in this document are subject to change by Innovations in Optics, Inc. (IOI) without notice. IOI assumes no liability for errors that may appear in this document, and no liability otherwise arising from the application or use of the product or information contained herein.